

Customer Information Sheet

DRAWING No.: M80-5T10805MI-04-331-00-000

SHEET 2 OF 2

IF IN DOUBT - ASK

©

NOT TO SCALE

THIRD ANGLE PROJECTION

ALL DIMENSIONS IN mm

SPECIFICATIONS:

MATERIAL:
 Moulding: GLASS FILLED PPS, UL94V-0, BLACK
 SIGNAL CONTACT: PHOSPHOR BRONZE
 POWER CONTACT: COPPER ALLOY
 JACKSCREW: STAINLESS STEEL

FINISH:
 SIGNAL CONTACT:
 0.75µ GOLD
 POWER CONTACT: GOLD

ELECTRICAL:
 WORKING VOLTAGE = 120V AC/DC
 VOLTAGE PROOF = 360V AC/DC
 INSULATION RESISTANCE = 100MΩ MIN
 SIGNAL CONTACT:
 CURRENT RATING AT 25°C = 3.0A MAX
 CURRENT RATING AT 85°C = 2.2A MAX
 CONTACT RESISTANCE = 25 mΩ MAX
 POWER CONTACT:
 CONTACT RESISTANCE 6 mΩ MAX
 CURRENT RATING = 20A MAX

MECHANICAL:
 DURABILITY = 500 OPERATIONS
 SIGNAL CONTACT:
 INSERTION FORCE = 2.8N MAX
 WITHDRAWAL FORCE = 0.2N MIN
 POWER CONTACT:
 INSERTION FORCE = 5N MAX
 WITHDRAWAL FORCE = 0.5N MIN

ENVIRONMENTAL:
 TEMPERATURE RANGE = -55°C TO +125°C

PACKING:
 TUBE
 FOR COMPLETE SPECIFICATION SEE COMPONENT SPECIFICATION C005XX (LATEST ISSUE)

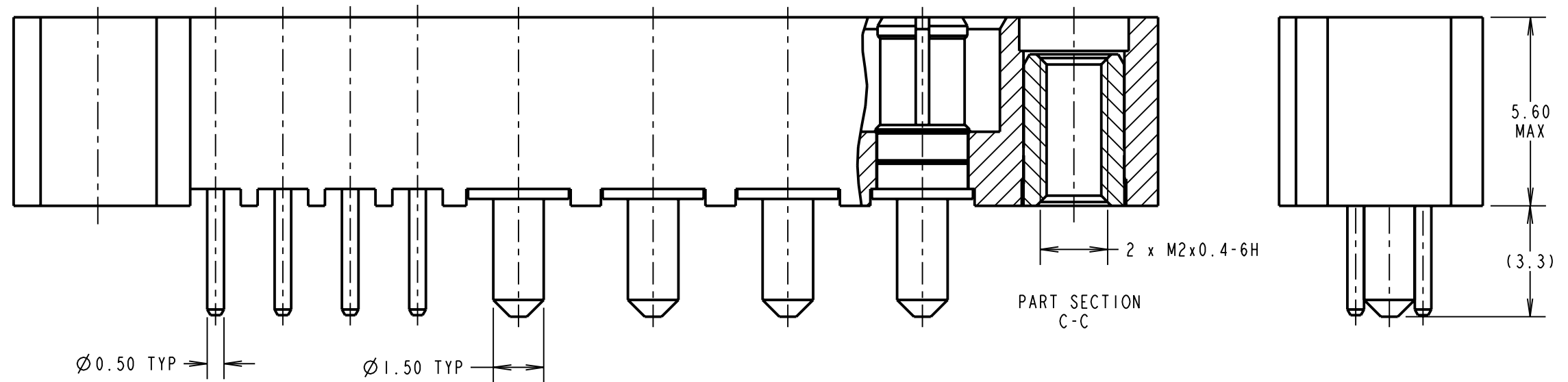
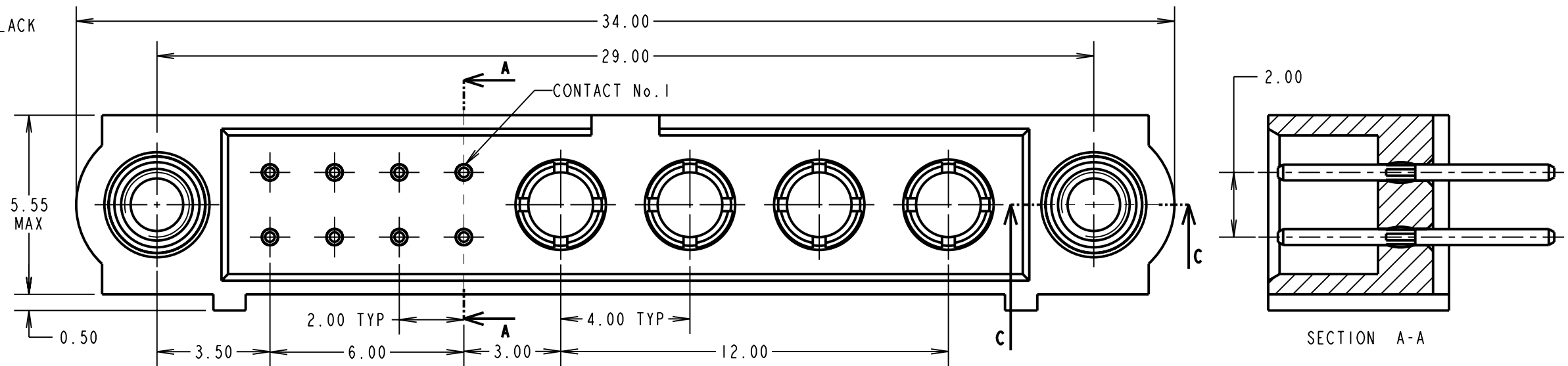

RECOMMENDED PCB LAYOUT

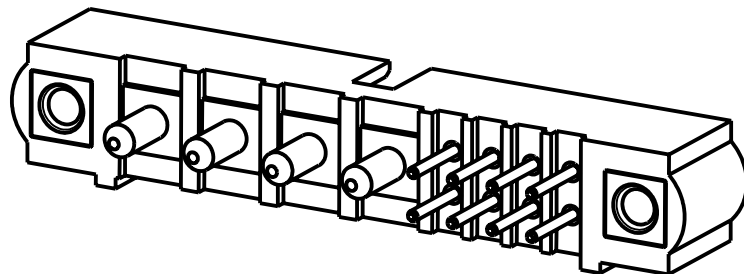
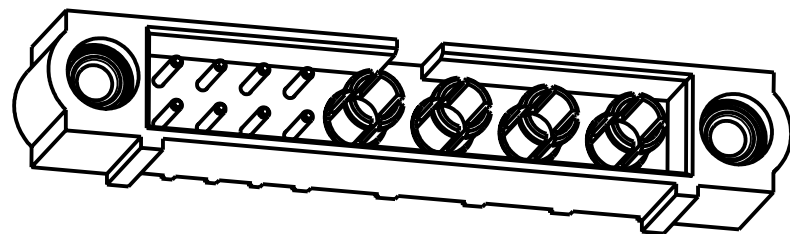
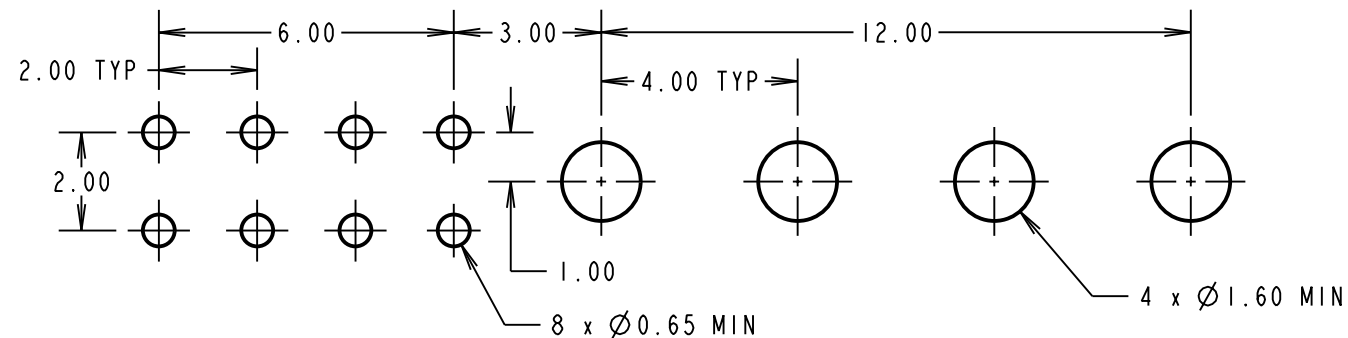

RA	A	09.04.09	----
NAME	ISS.	DATE	C/NOTE
APPROVED:		R. ADDE	
CHECKED:		M.G. PLESTED	
DRAWN:		R. ADDE	
CUSTOMER REF.:			
ASSEMBLY DRG:			

HARWIN

HARWIN USA
 TEL: 603 893 5376
 FAX: 603 893 5396
 mis@harwin.com

HARWIN Europe (UK)
 TEL: 023 9231 4545
 FAX: 023 9231 4590
 mis@harwin.co.uk

HARWIN Asia
 TEL: +65 6 779 4909
 FAX: +65 6 779 3868
 mis@harwin.com.sg

THIS DRAWING AND ANY INFORMATION OR DESCRIPTIVE MATTER SET OUT HEREON ARE CONFIDENTIAL AND COPYRIGHT PROPERTY OF THE HARWIN GROUP AND MUST NOT BE DISCLOSED, LOANED, COPIED OR USED FOR MANUFACTURING, TENDERING OR FOR ANY OTHER PURPOSE WITHOUT THEIR WRITTEN PERMISSION.

TOLERANCES
 X. = ±1mm
 X.X = ±0.25mm
 X.XX = ±0.10mm
 X.XXX = ±0.01mm
 ANGLES = ±5°
 UNLESS STATED

MATERIAL:
 SEE ABOVE

FINISH:
 SEE ABOVE

S/AREA:
 mm²

TITLE: JACKSCREW DATAMATE
 MIXED TECHNOLOGY
 PC TAIL MALE ASSEMBLY

DRAWING NUMBER:
 M80-5T10805MI-04-331-00-000

SHT
 2 OF 2